

COXUSA

ASSEMBLY PROCEDURES FOR PANEL DOORS/SERIES 21A

STEEL FRAME BYPASSING DOORS WITH "PRESS-LOCK" HARDWARE FOR 1/8" OR 5/32" (3mm or 4mm) PANEL INSERTS

#21-008
Fascia Spacer Clips

#12-100
Galvanized Steel Track

#21-253
Steel Fascia

#21-033
Non-Handed **Snap-In**
Single Wheel Top Roller Bracket
(Option: #21-036 Double Wheel)

#21-133
Steel Rails

#21-301
Panel Stiffener (Optional)

#21-323
Steel Stiles with Integral Pull

#21-032
Non-Handed **Snap-In**
Self-Adjusting Bottom
Guide Bracket

#21-653
Steel V-Groove Threshold

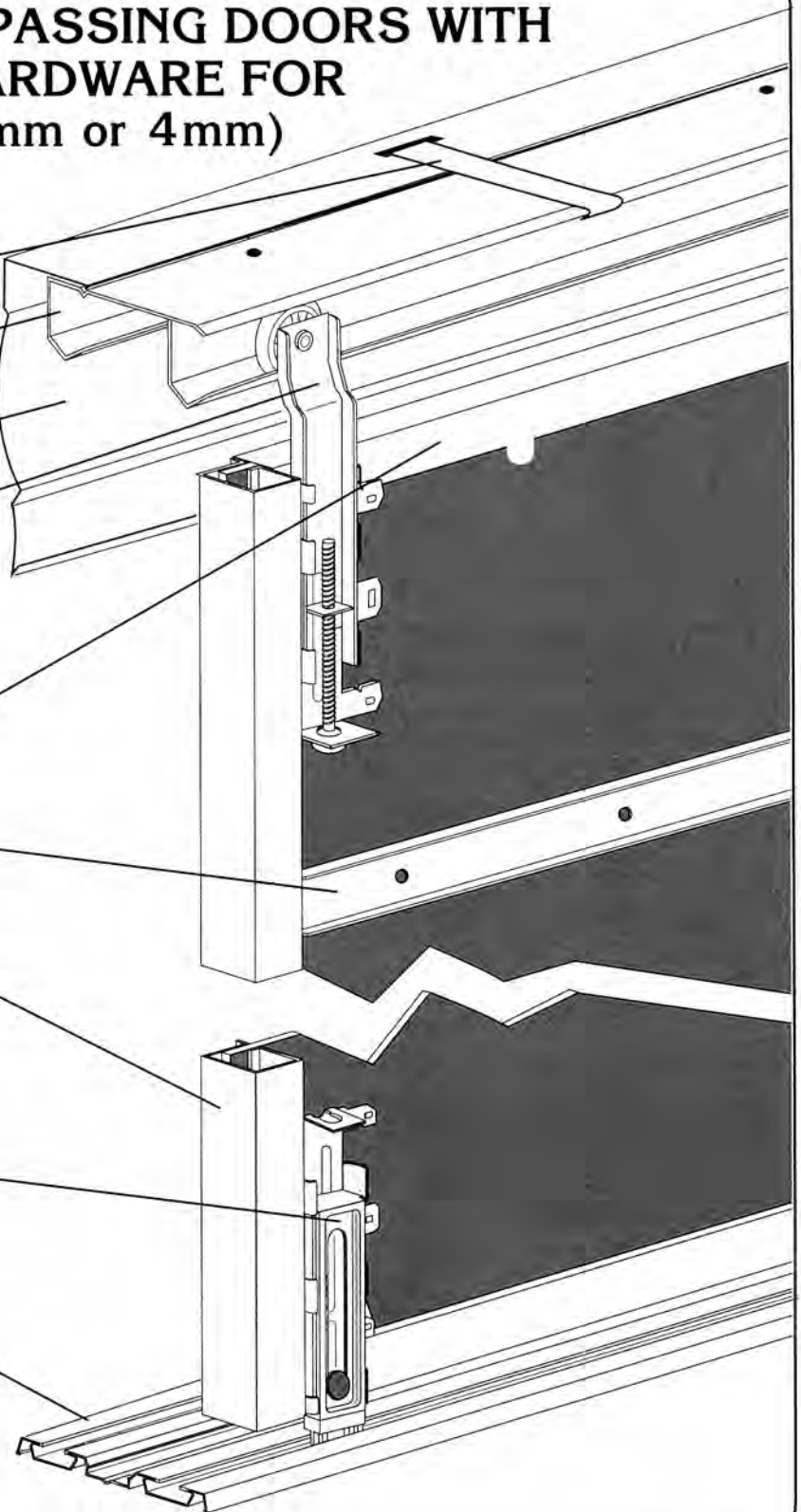

ASSEMBLY INSTRUCTIONS

1. SIZE DOORS TO FIT OPENINGS

STILE HEIGHT

NET FINISHED OPENING HEIGHT	PANEL LENGTH	STILE LENGTH
80 1/2" (204.5cm)	77 7/8" (197.8cm)	78" (198.1cm)
84" (213.4cm)	81 3/8" (206.7cm)	81 1/2" (207.0cm)
96" (243.8cm)	93 3/8" (237.2cm)	93 1/2" (237.5cm)
98 1/2" (250.2cm)	95 7/8" (243.5cm)	96" (243.8cm)

RAIL WIDTH

NET FINISHED OPENING WIDTH	NO. DOORS	PANEL WIDTH	RAIL WIDTH
47" (119.4cm)	2	24" (61.0cm)	22 1/2" (57.2cm)
54" (137.2cm)	2	27 1/2" (69.9cm)	26" (66.0cm)
59" (149.9cm)	2	30" (76.2cm)	28 1/2" (72.4cm)
66" (167.6cm)	2	33 1/2" (85.1cm)	32" (81.3cm)
71" (180.3cm)	2	36" (91.4cm)	34 1/2" (87.6cm)
78" (198.1cm)	2	39 1/2" (100.3cm)	38" (96.5cm)
83" (210.8cm)	2	42" (106.7cm)	40 1/2" (102.9cm)
90" (228.6cm)	2	45 1/2" (115.6cm)	44" (111.8cm)
95" (241.3cm)	2	48" (121.9cm)	46 1/2" (118.1cm)
106" (269.2cm)	3	36" (91.4cm)	34 1/2" (87.6cm)
118" (299.7cm)	3	42" (106.7cm)	40 1/2" (102.9cm)
142" (360.7cm)	3	48" (121.9cm)	46 1/2" (118.1cm)

2. TAP ON RAILS AND STILES WITH RUBBER Mallet

First center rails on each end of panel. Then tap stiles onto sides of panel. Align corners to receive hangers and guides. Allow 3/32" (2.4mm) gap as shown.

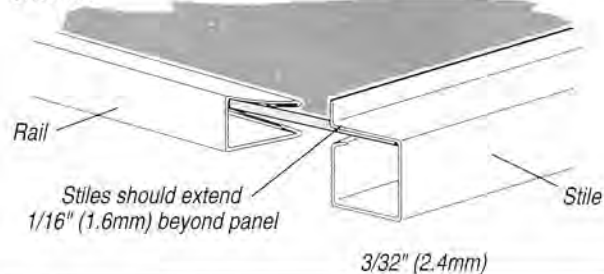

3. INSERT HANGERS INTO SLOTS – PRESS IN UNTIL CORNER IS LOCKED INTO PLACE

Insert hangers into 3 alignment slots in top rail and stile. Press in by hand (pressure must be applied at center of hanger until spur locks under stile.) Repeat procedure with other hanger.

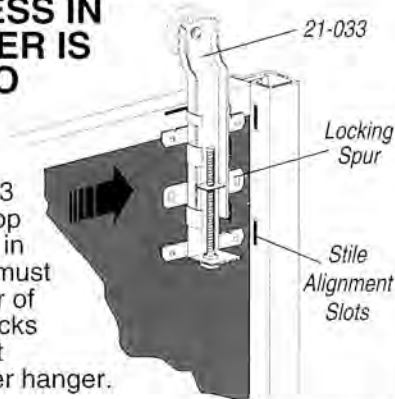

4. PRESS IN BOTTOM GUIDES

Repeat Step 3 to attach guides at bottom corners. Frame is now securely locked in perfect alignment to panel insert by hangers and guides at each corner, ready for installation.

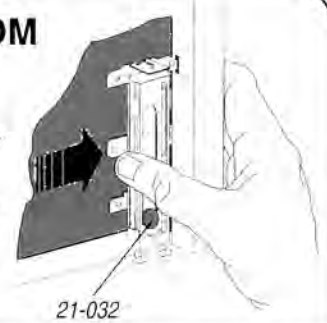

5. SPECIAL COX HAND TOOL #05-210 FOR IN-THE-FIELD PUNCHING OF ALIGNMENT SLOTS

This special tool (#05-210) is available for in-the-field punching of stile or rail when necessary for special sizes. See instruction sheet.

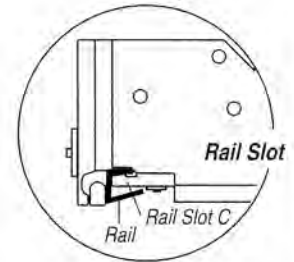
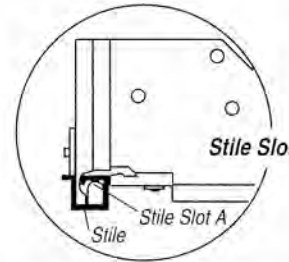
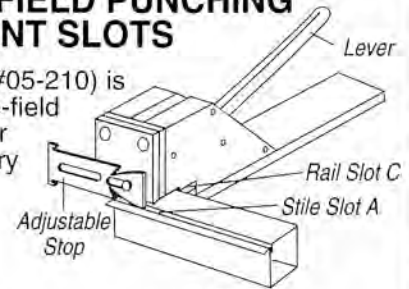

TO FIGURE SPECIAL SIZES:

- PANEL HEIGHT: – Finished opening height less (-) 2 5/8" (66.7mm)
- PANEL WIDTH: – Finished opening width plus (+) 1" (25.4mm) per overlap divided (÷) by number of doors.
- STILE LENGTH: – Cut 1/8" (3.2mm) longer than panel height – repunch with 05-210 tool.
- RAIL LENGTH: – Cut 1 1/2" (38.1mm) less than panel width – repunch with 05-210 tool.

NOTE: When cutting stiles and rails, use a fine tooth hacksaw (32 teeth per inch blade).

6. Install Optional Panel Stiffener

Position stiffener at slight angle against BACK of prefinished panel. Rotate stiffener until end tabs are engaged between stiles and panel, parallel to rails. More than one stiffener may be required for larger doors. Apply hot glue between center 12" of stiffener and panel. Press together forcing glue through holes in stiffener maintaining pressure until glue sets. Any 3M® High Temperature Polygun TC Applicator and 3M® #3747 Tan General Purpose Hot Glue (5/8" x 8" Quadrack Sticks) are suggested.

Special sizes: cut stiffener to length. Install #21-011 panel stiffener clip at cut end and install.

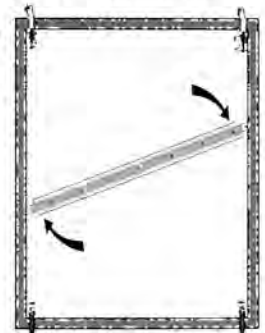

INSTALLATION INSTRUCTIONS

1. FIT DOORS TO OPENINGS

WIDTHS		HEIGHTS	
OPENING	DOOR	OPENING	DOOR
47" (119.4cm)	24" (61.0cm)	80 1/2" (204.5cm)	78" (198.1cm)
54" (137.2cm)	27 1/2" (69.9cm)	84" (213.4cm)	81 1/2" (207.0cm)
59" (149.9cm)	30" (76.2cm)	96" (243.8cm)	93 1/2" (237.5cm)
66" (167.6cm)	33 1/2" (85.1cm)	98 1/2" (250.2cm)	96" (243.8cm)
71" (180.3cm)	36" (91.4cm)		
78" (198.1cm)	39 1/2" (100.3cm)		
83" (210.8cm)	42" (106.7cm)		
90" (228.6cm)	45 1/2" (115.6cm)		
95" (241.3cm)	48" (121.9cm)		
106" (269.2cm)	36" (91.4cm)		
118" (299.7cm)	42" (106.7cm)		
142" (360.7cm)	48" (121.9cm)		

Doors should be 2 1/2" (63.5mm) less than finished opening height. Doors should overlap a minimum of 1" (25.4mm).

4. ATTACH ASSEMBLED TRACK/FASCIA TO HEADER OR CEILING

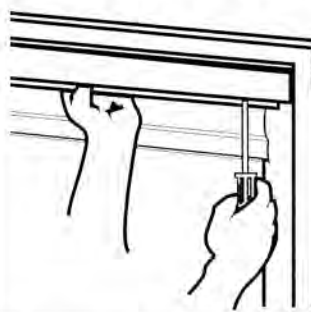

5. ATTACH THRESHOLD TO FLOOR WITH SCREWS OR MASTIC

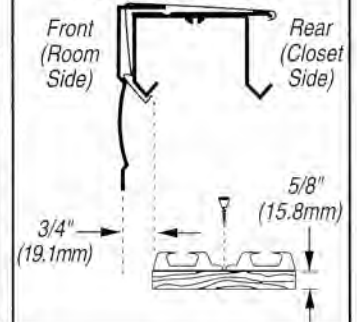

2. CUT #21-253 FASCIA TO EXACT OPENING WIDTH

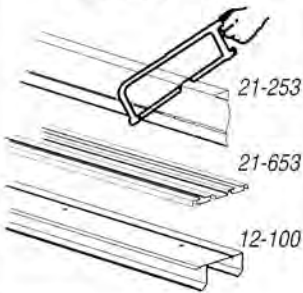

#12-100 Track and #21-653 Threshold are pre-cut for standard widths 47" (119.4cm), 59" (149.9cm), 71" (180.3cm), 83" (210.8cm) and 95" (241.3cm). For other non-standard widths track and threshold must also be cut to size using a fine tooth hacksaw (32 teeth per inch blade).

6. HANG DOORS



Hang rear door first. Stand under track with back toward closet. Tilt bottom of door out, away from opening. Insert hangers into track and allow door to swing into position.



3. ASSEMBLE TRACK AND FASCIA WITH SPRING CLIP #21-008

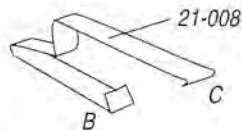
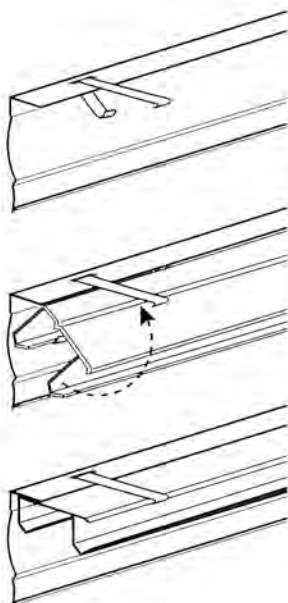

- A – Insert spring clip #21-008 into slot on top of fascia.
- B – Place front runner of track into bottom leg of clips (B).
- C – Swing track up to engage top leg of clip (C).
- D – Snap spring clip over back edge of track. Fascia assembly is now ready for installation as one unit.

7. INSERT NYLON GUIDES INTO THRESHOLD

Loosen nylon guide with screwdriver as shown. Press bottom lip of nylon guide into threshold until locked. Guide may be removed by depressing guide lip (A) and lifting up.

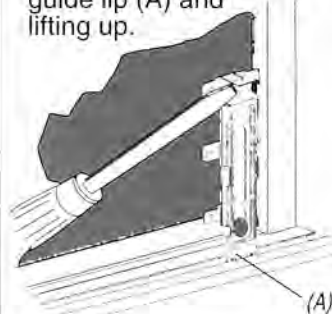

8. ADJUST DOORS

Horizontal or vertical adjustment with easy-to-reach adjusting screw on hanger (A). Adjust hanger until door stile is parallel with jamb.

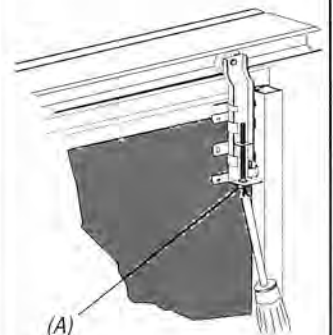

FRAMING COMPARISON

Typical

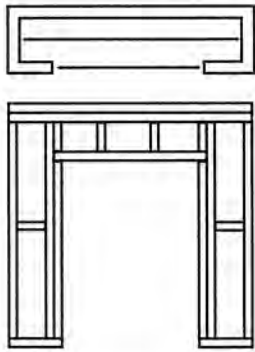

Series 21A

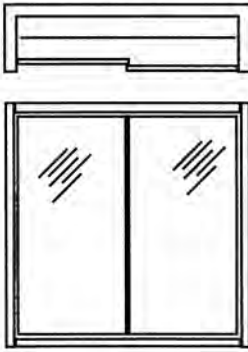

EXCLUSIVE FEATURES OF COX SERIES 21A HARDWARE

- Prefinished baked enamel track and contoured fascia adds that touch of elegance. V-shaped wheel section provides effortless jump-proof performance. Single door steel track is also available.
- Exclusive "Press-lock" hangers are locked to stiles and rails at top corners. Cox exclusive spoke design wheels assure true concentricity.
- All steel prefinished in a choice of 5 decorator colors.
- Integral door pull stiles provides finger-tip operation. Fits 1/8" or 5/32" (3mm or 4mm) panel inserts.
- Exclusive "Press-lock" guides securely lock stiles and rails at bottom corners. Floating nylon guides conform to floor contour as they ride in threshold.
- Steel "V-groove" threshold may be installed with either 5/8" (15.8mm) installation screws or mastic.
- Prefinished baked enamel threshold holds nylon guides in track. Single door threshold is also available.

ARCHITECTURAL SPECIFICATIONS

Sliding doors shall be guided by Cox Series 21A 2-piece steel fascia track. Hangers shall be Cox Series 21A of plated steel with vertical adjustment provided by easy screw action and spoke design Celcon® wheels.

Doors shall be guided at bottom by Cox Series 21A nylon adjustable guides and prefinished baked enamel V-groove threshold. Doors shall be assembled with prefinished baked enamel steel door pull stiles and rails on 1/8" or 5/32" (3mm or 4mm) panel inserts.

Track, threshold and other hardware shall be manufactured by Arthur Cox & Sons, Incorporated, Industry, California.

COXusa

4755 E. ZINFANDEL COURT, SUITE D | ONTARIO, CA 91761
P 909/545-8900 | F 909/975-4801 | WWW.COXUSA.US

